

Article number: 0101038
 Description: Retaining ring A 21 DIN 471
 Spring steel
 Note: Fitted with ZGA pilers

Measures

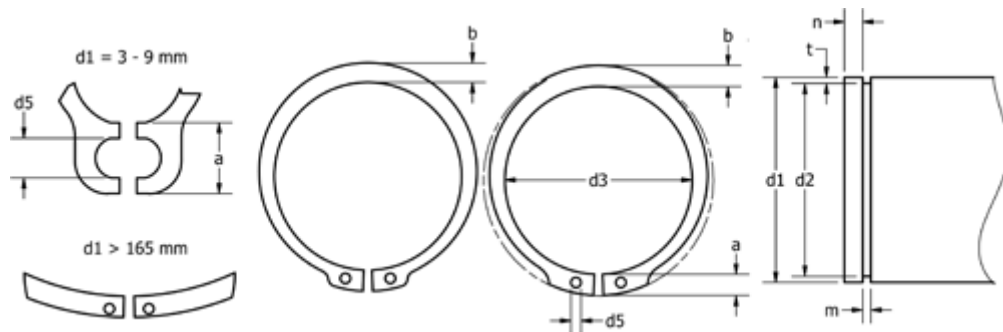

a max	= 4.1	FN kN	= 5.3	s	= 1.20
AN mm ²	= 32.2	FRg kN	= 3.75	t	= 0.50
b	= 2.7	FR kN	= 16.80	tol	= -0.13
d1	= 21	g	= 1.5	tol	= -0.06
d2	= 20.0	K kN-mm	= 35.40	tol	= +0,13-0,42
d3	= 19.5	m min	= 1.30	Tong	= ZGA-2
d5 min	= 2.0	n abl x 1000	= 29.0	Weight kg/1000	= 1.420
Description	= A21	Nominal drive	= 1.5		